

D-NAMIC

92 Shore A  
+90°C  
-40°C

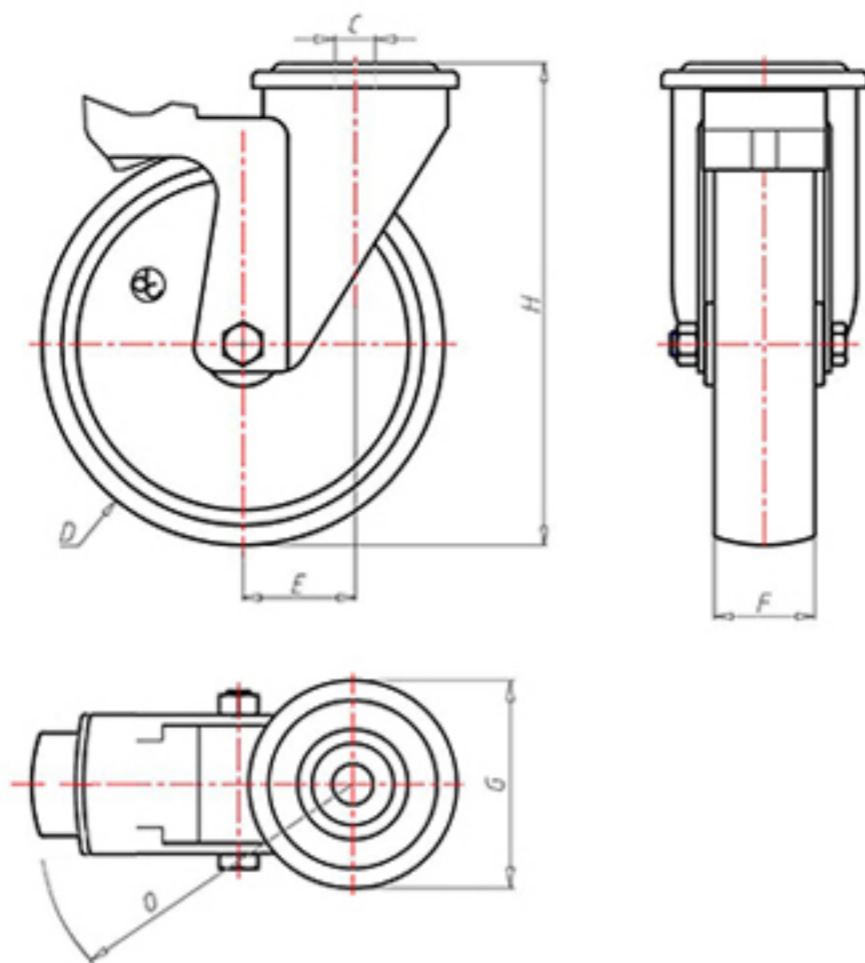

	D	80
	F	33
	H	108
	G	Ø 77
	C	Ø 12
	E	40
	O	124
	LC	200



Code for plain bore wheel

XNPZ8045FS



Code for wheel with roller bearing

XNPZ8045RFS



Code for wheel with double sealed ball bearing

XNPZ80CFS



Code for wheel with double sealed Inox ball bearing

-

