

D-NAMIC

92 Shore A
+90°C
-40°C

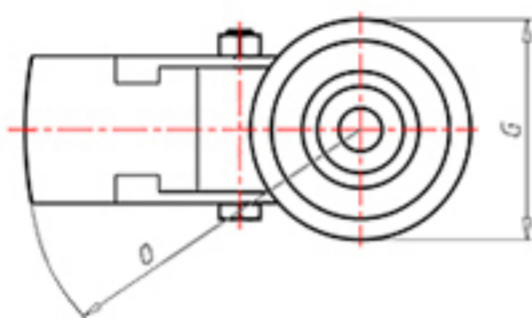

	D	80
	F	33
	H	108
	G	Ø 77
	C	Ø 12
	E	40
	O	124
	LC	200

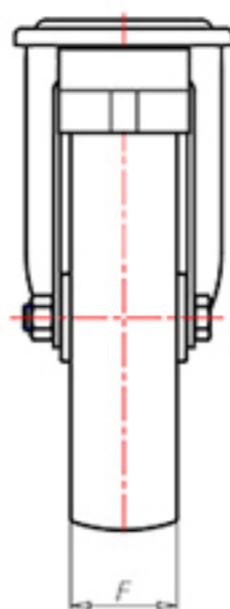
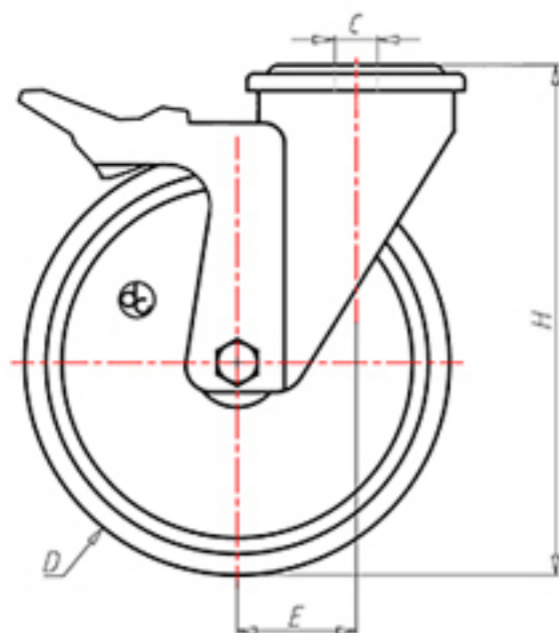

Code for plain bore wheel

XNPZ8045FA



Code for wheel with roller bearing

XNPZ8045RFA



Code for wheel with double sealed ball bearing

XNPZ80CFA



Code for wheel with double sealed Inox ball bearing

-

