

D-NAMIC

92 Shore A
+90°C
-40°C

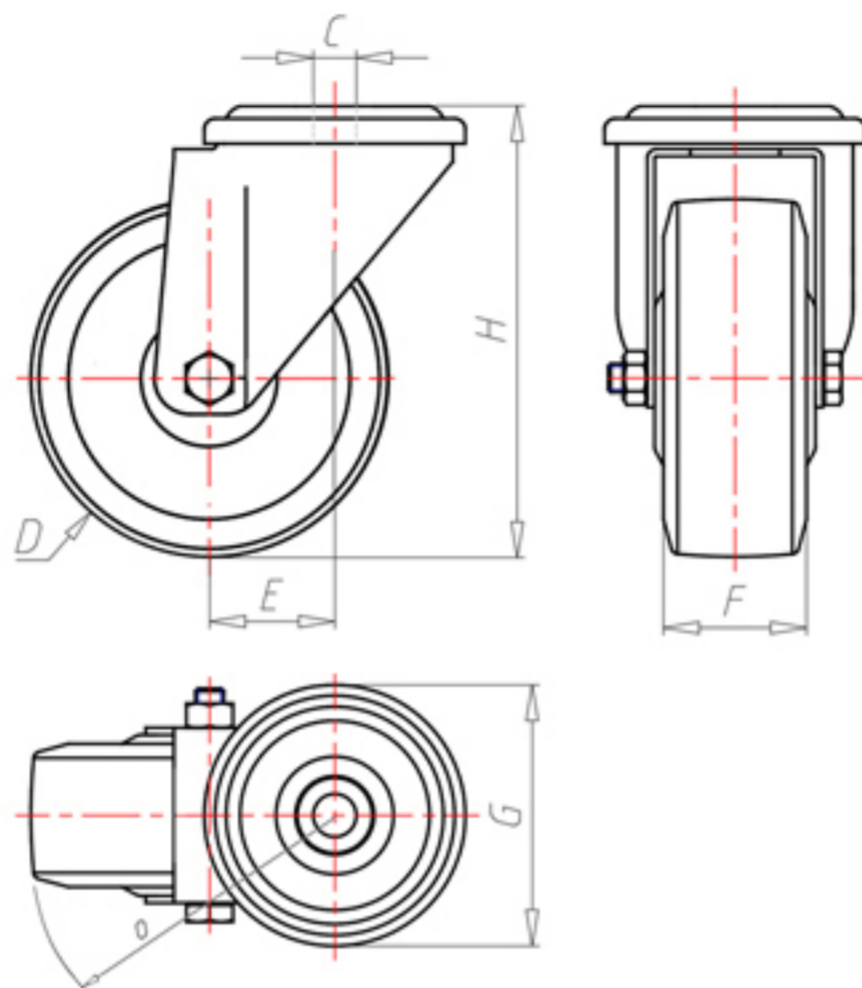

	D	150
	F	40
	H	181
	G	Ø 102
	C	Ø 16
	E	52
	O	124
	LC	350



Code for plain bore wheel

XNPZ15060



Code for wheel with roller bearing

XNPZ15060R



Code for wheel with double sealed ball bearing

XNPZ15060C



Code for wheel with double sealed Inox ball bearing

-

