

D-NAMIC

92 Shore A
+90°C
-40°C

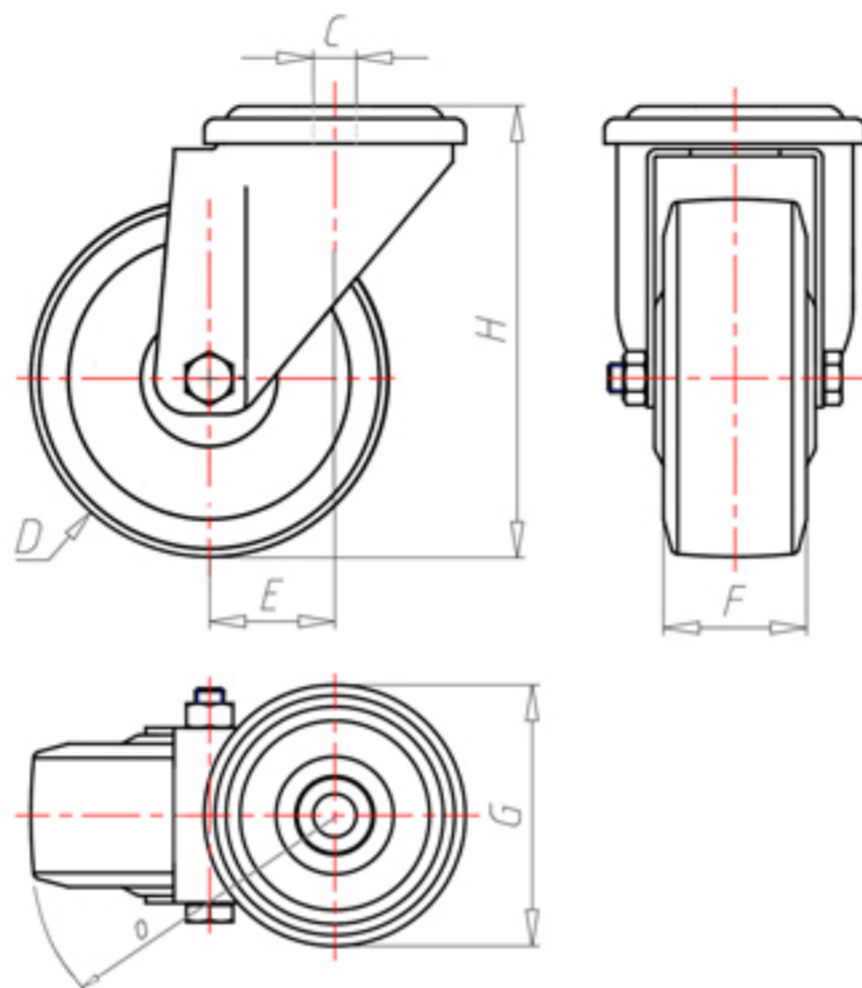

	D	100
	F	33
	H	128
	G	Ø 77
	C	Ø 12
	E	42
	O	92
	LC	220



Code for plain bore wheel

XNPZ10040



Code for wheel with roller bearing

XNPZ10040R



Code for wheel with double sealed ball bearing

XNPZ10040C



Code for wheel with double sealed Inox ball bearing

-

