

D-NAMIC

92 Shore A  
+90°C  
-40°C

INOX

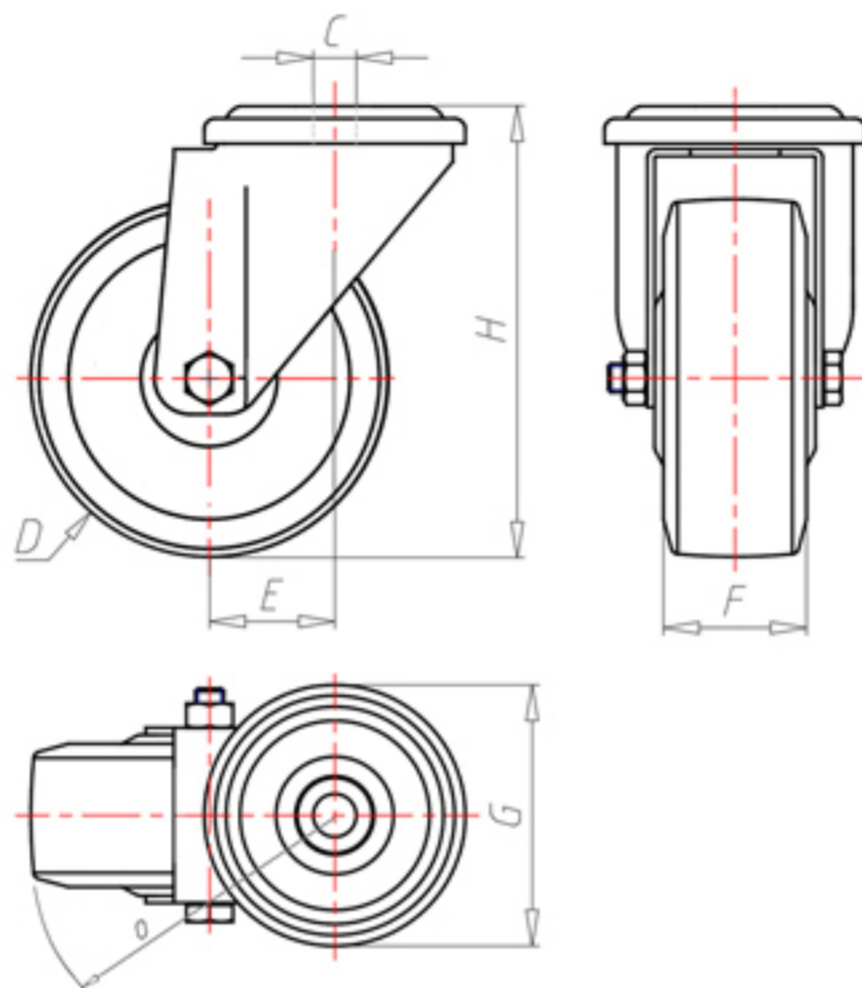

	D	80
	F	33
	H	108
	G	Ø 77
	C	Ø 12
	E	40
	O	82
	LC	200



Code for plain bore wheel

XNPX8040



Code for wheel with Inox roller bearing

XNPX8040RX



Code for wheel with double sealed ball bearing

XNPX8040C



Code for wheel with double sealed Inox ball bearing

XNPX8040CX

