

D-NAMIC

92 Shore A
+90°C
-40°C

INOX

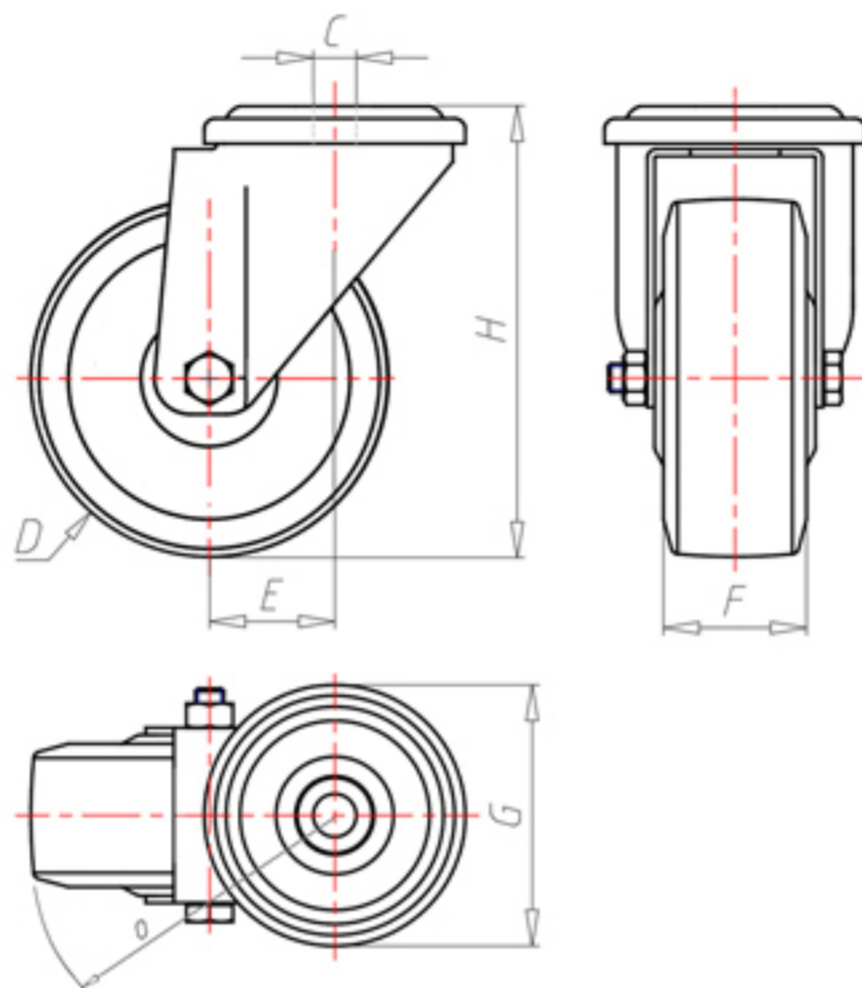

	D	100
	F	33
	H	128
	G	Ø 77
	C	Ø 12
	E	42
	O	92
	LC	220



Code for plain bore wheel

XNPX10040



Code for wheel with Inox roller bearing

XNPX10040RX



Code for wheel with double sealed ball bearing

XNPX10040C



Code for wheel with double sealed Inox ball bearing

XNPX10040CX

