

D-NAMIC

92 Shore A
+90°C
-40°C

INOX

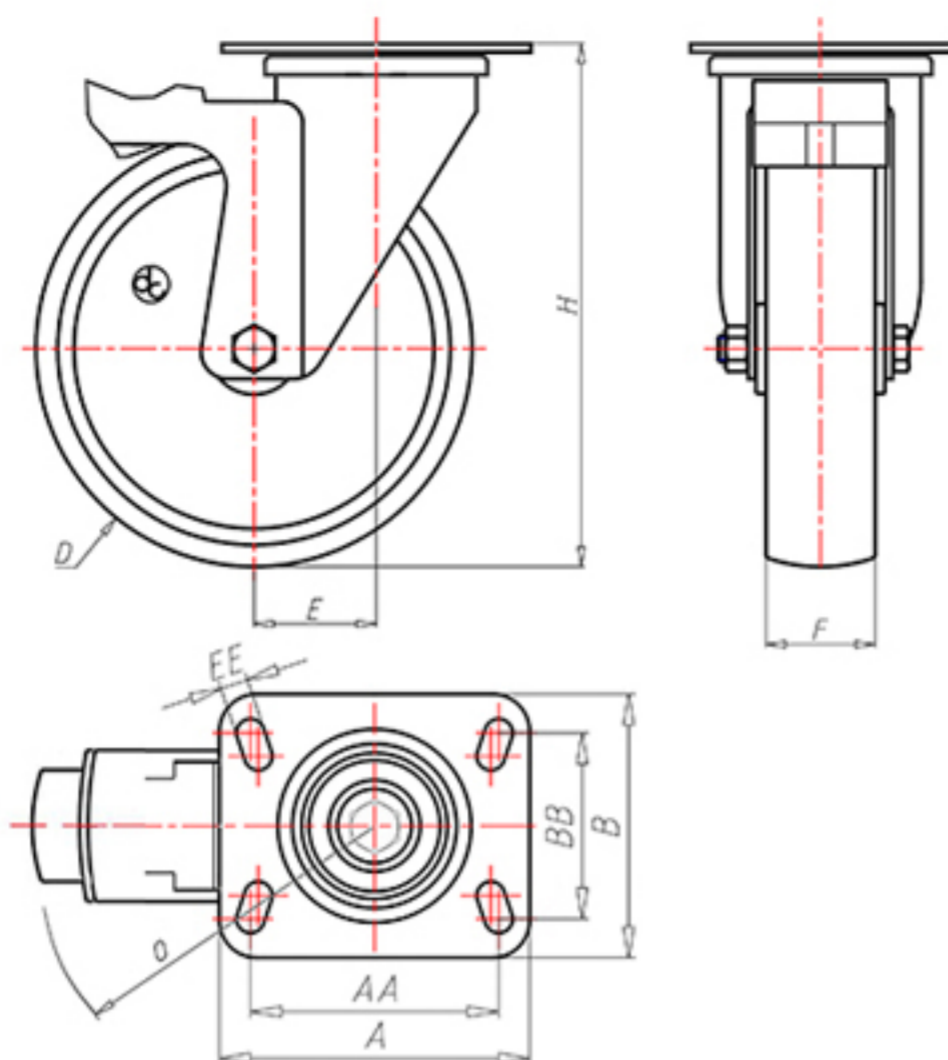

	D	80
	F	33
	H	110
	AxB	100x85
	AAxBB	80x60
	EE	9
	E	40
	O	124
	LC	210



Code for plain bore wheel

XNGX8045PFS



Code for wheel with Inox roller bearing

XNGX8045PRXFS



Code for wheel with double sealed ball bearing

XNGX80PCFS



Code for wheel with double sealed Inox ball bearing

XNGX80PCXFS

