

D-NAMIC

92 Shore A  
+90°C  
-40°C

INOX

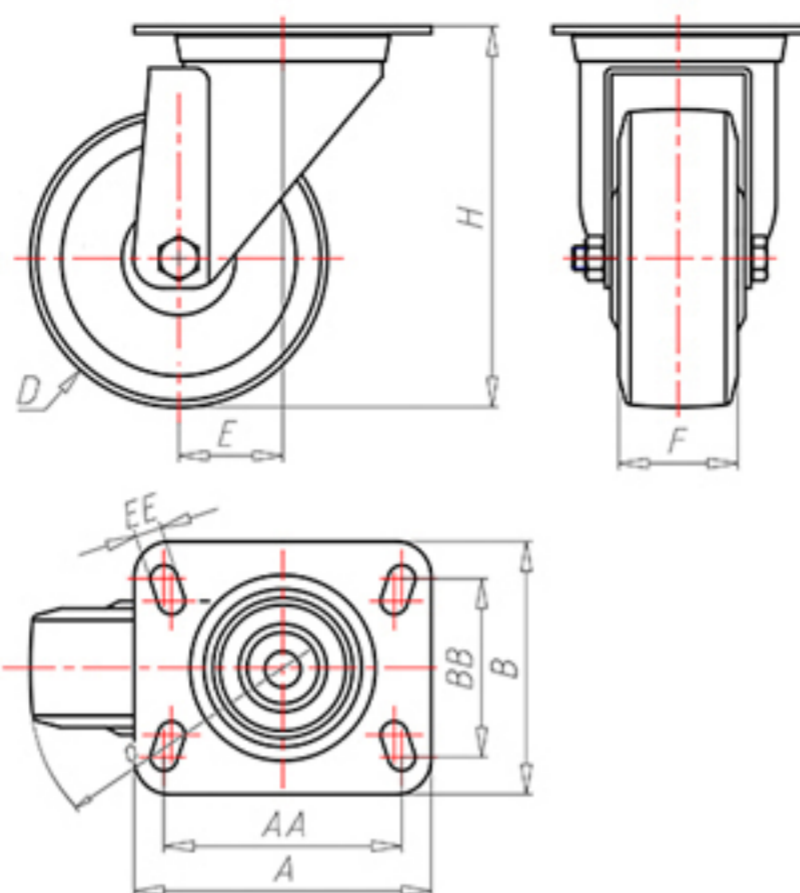

	D	80
	F	33
	H	108
	AxB	100x85
	AAxBB	80x60
	EE	9
	E	40
	O	82
	LC	200



Code for plain bore wheel

XNGX8045



Code for wheel with Inox roller bearing

XNGX8045RX



Code for wheel with double sealed ball bearing

XNGX80C



Code for wheel with double sealed Inox ball bearing

XNGX80CX

