

D-NAMIC

92 Shore A
+90°C
-40°C

INOX

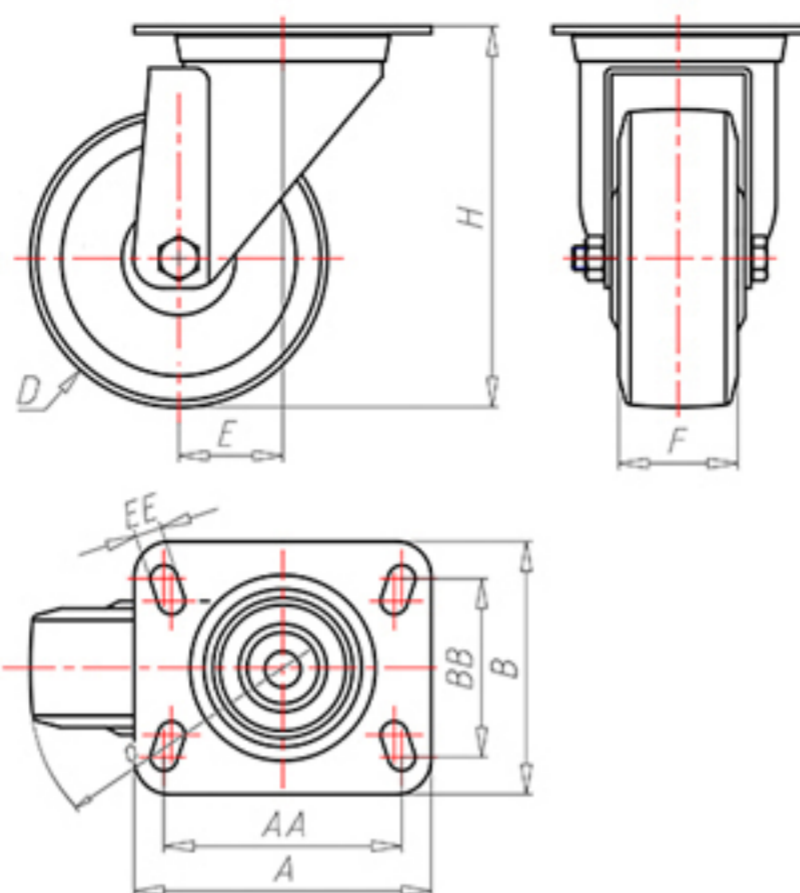

	D	200
	F	50
	H	232
	AxB	135x110
	AAxBB	105x80
	EE	11
	E	56
	O	167
	LC	400



Code for plain bore wheel

XNGX20060



Code for wheel with Inox roller bearing

XNGX20060RX



Code for wheel with double sealed ball bearing

XNGX20060C



Code for wheel with double sealed Inox ball bearing

XNGX20060CX

