

D-NAMIC

92 Shore A
+90°C
-40°C

INOX

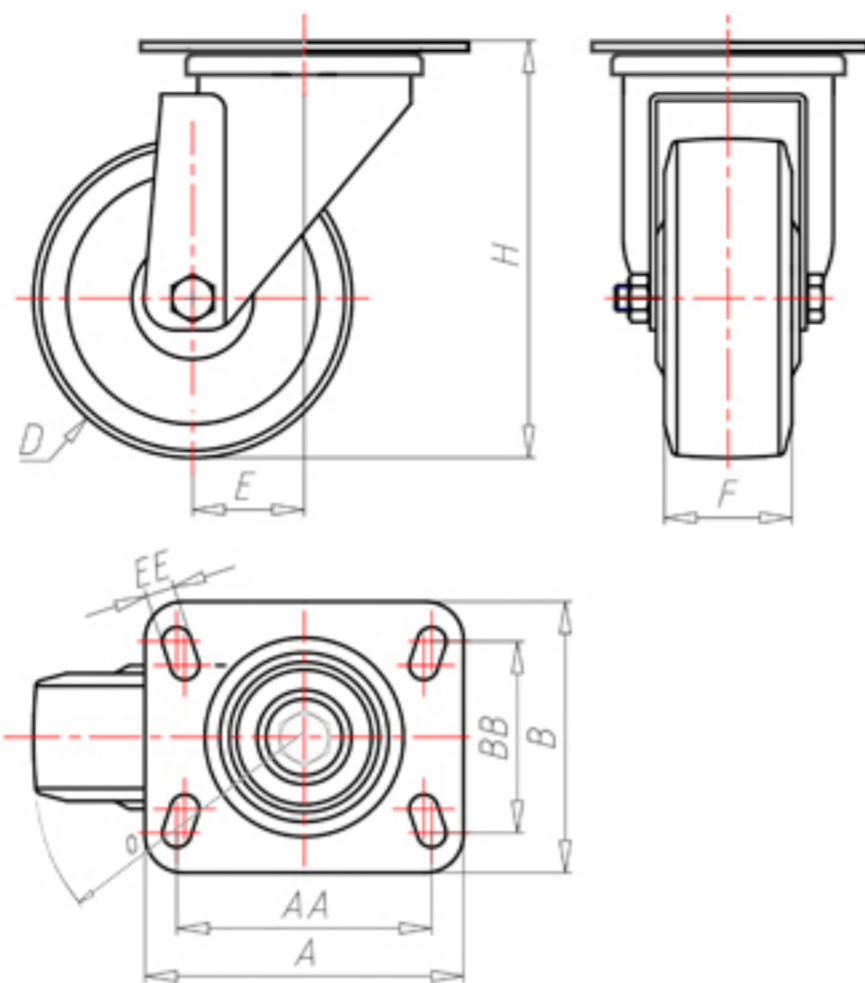

	D	150
	F	40
	H	184
	AxB	135x110
	AAxBB	105x80
	EE	11
	E	52
	O	120
	LC	350



Code for plain bore wheel

XNGX15060P



Code for wheel with Inox roller bearing

XNGX15060PRX



Code for wheel with double sealed ball bearing

XNGX15060PC



Code for wheel with double sealed Inox ball bearing

XNGX15060PCX

