

D-NAMIC

92 Shore A
+90°C
-40°C

INOX

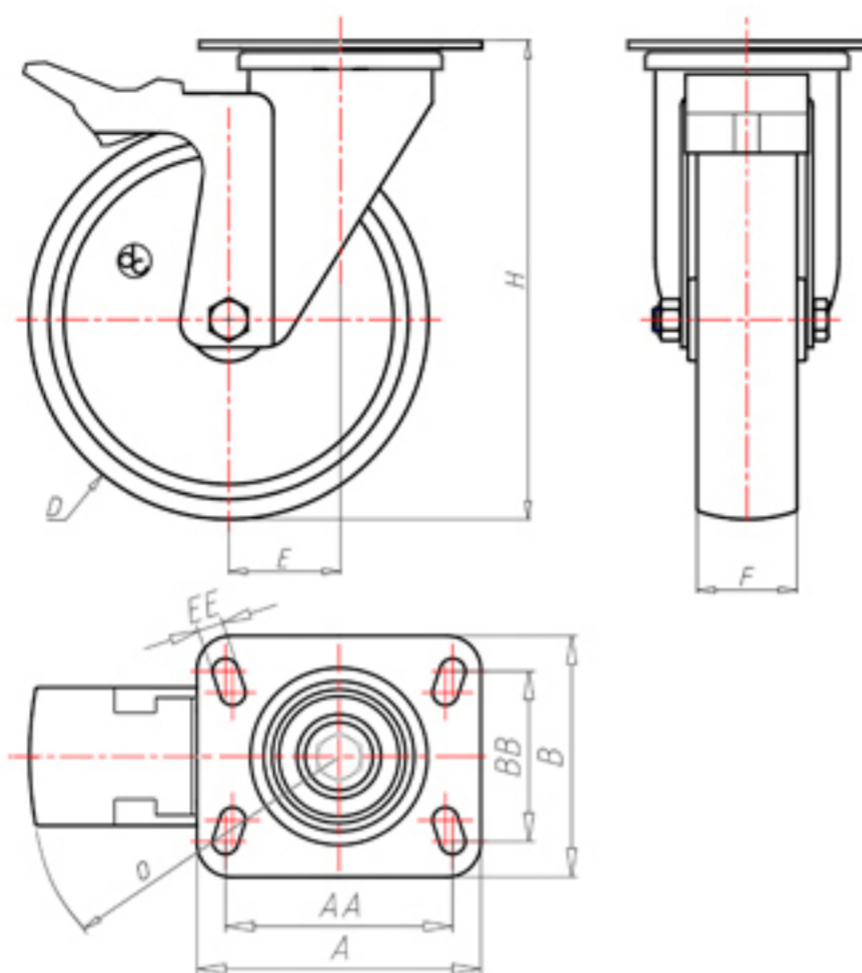

	D	150
	F	40
	H	184
	AxB	100x85
	AAxBB	80x60
	EE	9
	E	46
	O	124
	LC	280



Code for plain bore wheel

XNGX15045PFA



Code for wheel with Inox roller bearing

XNGX15045PRXFA



Code for wheel with double sealed ball bearing

XNGX15045PCFA



Code for wheel with double sealed Inox ball bearing

XNGX15045PCXFA

