

D-NAMIC

92 Shore A  
+90°C  
-40°C

INOX

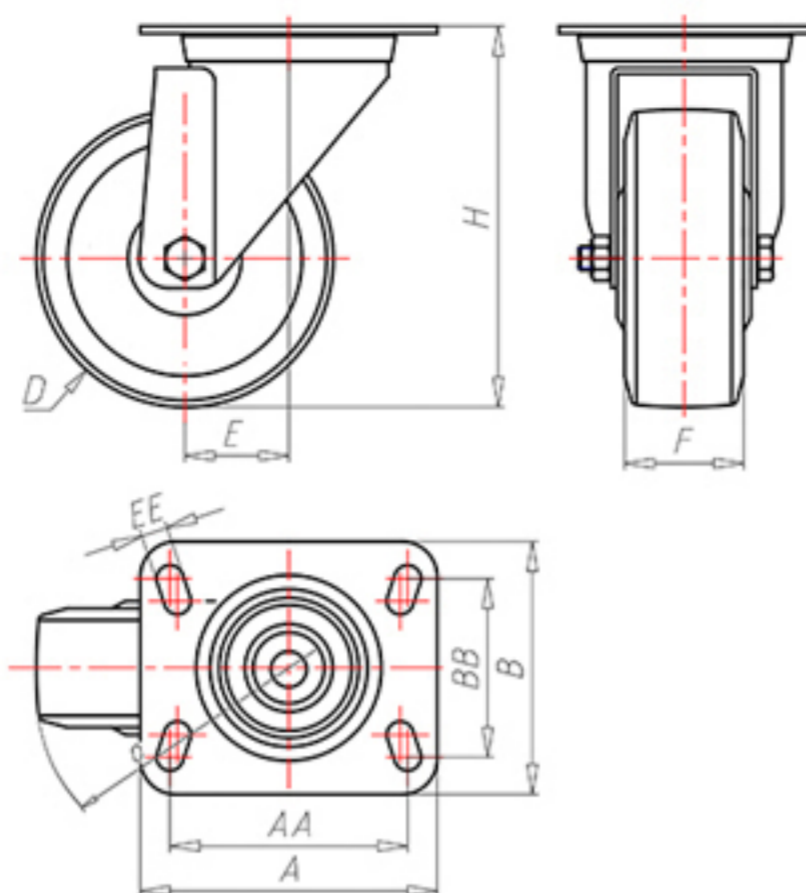

	D	150
	F	40
	H	181
	AxB	100x85
	AAxBB	80x60
	EE	9
	E	46
	O	120
	LC	250



Code for plain bore wheel

XNGX15045



Code for wheel with Inox roller bearing

XNGX15045RX



Code for wheel with double sealed ball bearing

XNGX15045C



Code for wheel with double sealed Inox ball bearing

XNGX15045CX

