

D-NAMIC

92 Shore A
+90°C
-40°C

INOX

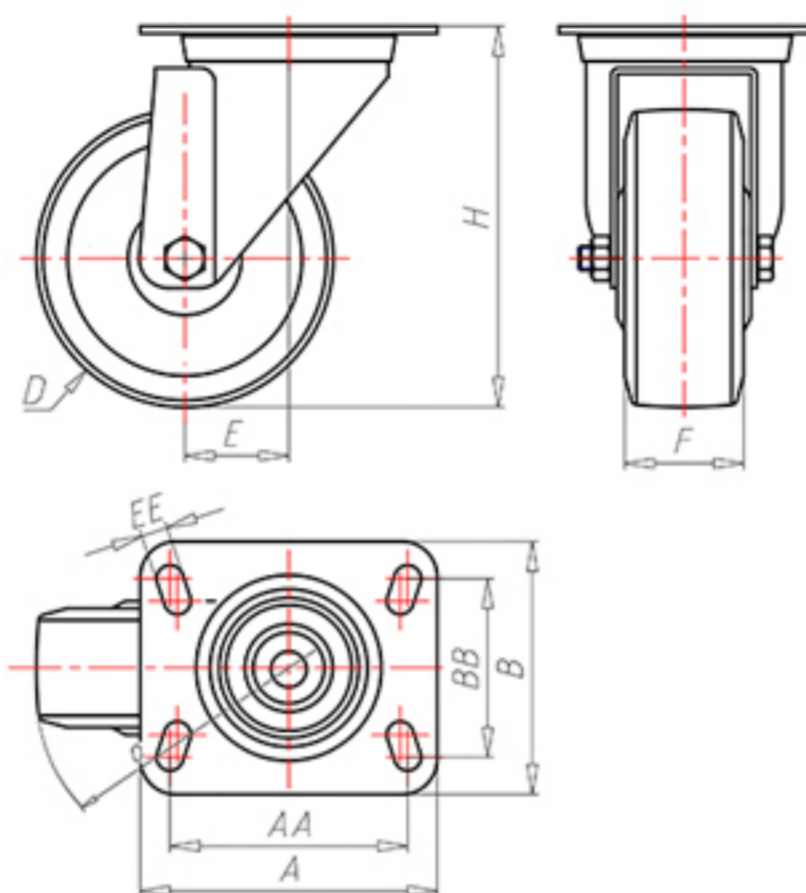

	D	100
	F	33
	H	128
	AxB	100x85
	AAxBB	80x60
	EE	9
	E	42
	O	92
	LC	220



Code for plain bore wheel

XNGX10045

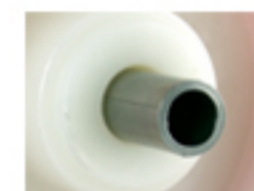

Code for wheel with Inox roller bearing

XNGX10045RX



Code for wheel with double sealed ball bearing

XNGX100C



Code for wheel with double sealed Inox ball bearing

XNGX100CX

