

D-NAMIC

92 Shore A
+90°C
-40°C

INOX

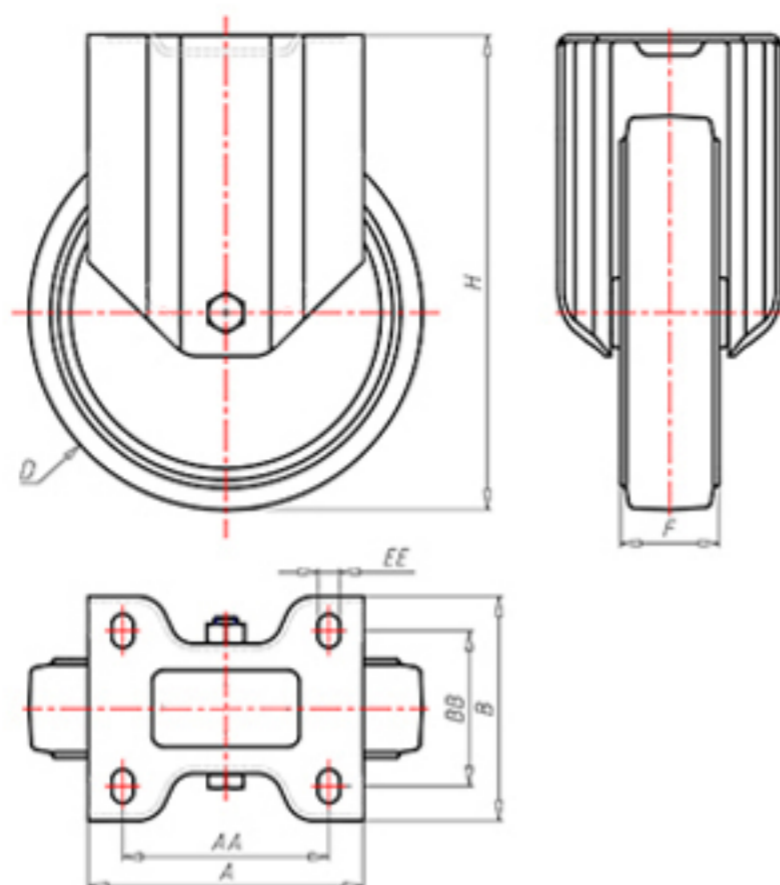

	D	150
	F	40
	H	181
	AxB	100x85
	AAxBB	80x60
	EE	9
	B	
	AA	
	A	
	LC	280



Code for plain bore wheel

XNFX15045



Code for wheel with Inox roller bearing

XNFX15045RX



Code for wheel with double sealed ball bearing

XNFX15045C



Code for wheel with double sealed Inox ball bearing

XNFX15045CX

