

D-NAMIC

92 Shore A
+90°C
-40°C

INOX

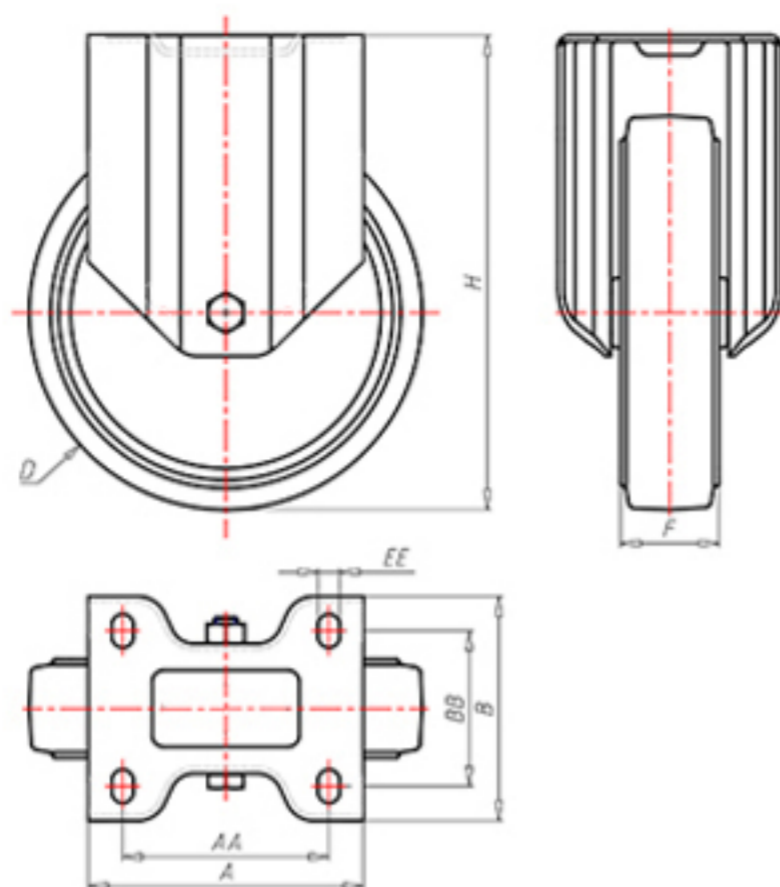

	D	100
	F	33
	H	128
	AxB	100x85
	AAxBB	80x60
	EE	9
	B	
	AA	
	A	
	LC	250



Code for plain bore wheel

XNFX10040



Code for wheel with Inox roller bearing

XNFX10040RX



Code for wheel with double sealed ball bearing

XNFX10040C



Code for wheel with double sealed Inox ball bearing

XNFX10040CX

