

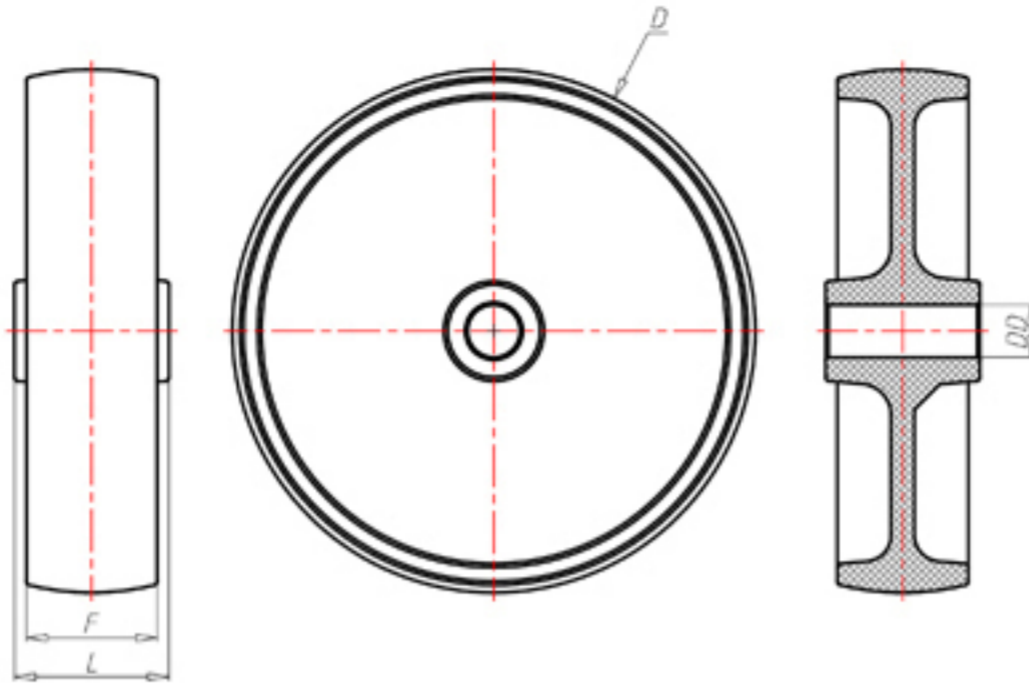

+280°C
-70°C



	D	80
	F	30
	L	45
	DD	Ø 10
	LC	300



Code for plain bore wheel

-



Code for wheel with coated bush

-



Code for wheel with double BT self-lube bush

STW80BT



Code for wheel with double HT ball bearing

-



Code wheel with double sintered bronze bush

-

