

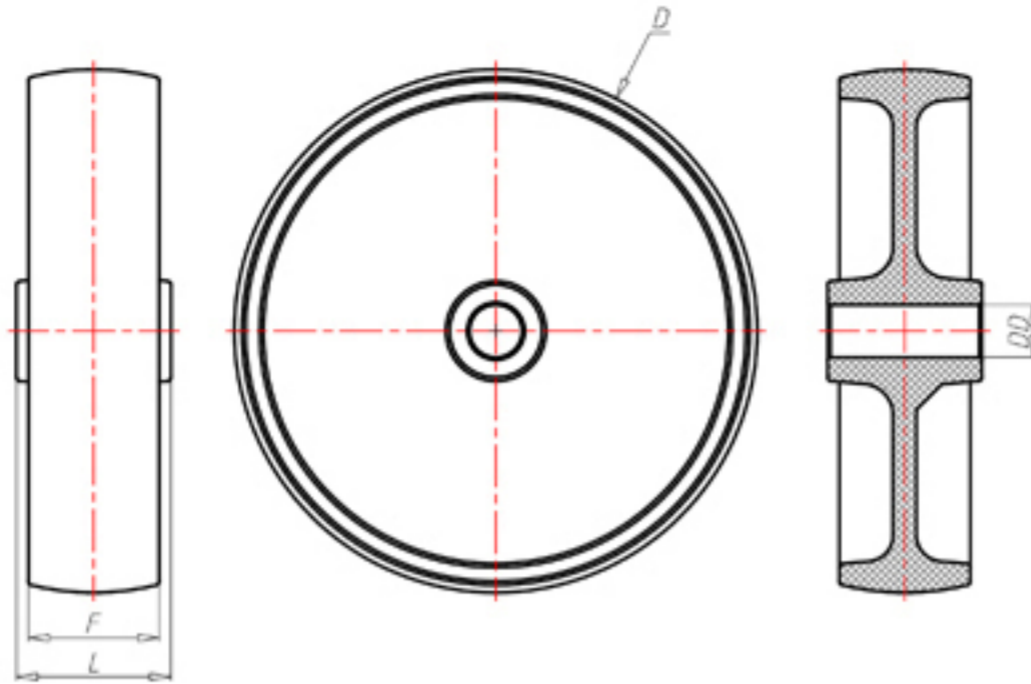

+280°C
-70°C



	D	80
	F	30
	L	40
	DD	Ø 8
	LC	300



Code for plain bore wheel

-



Code for wheel with coated bush

STW80BR



Code for wheel with double BT self-lube bush

-



Code for wheel with double HT ball bearing

-



Code wheel with double sintered bronze bush

-

