

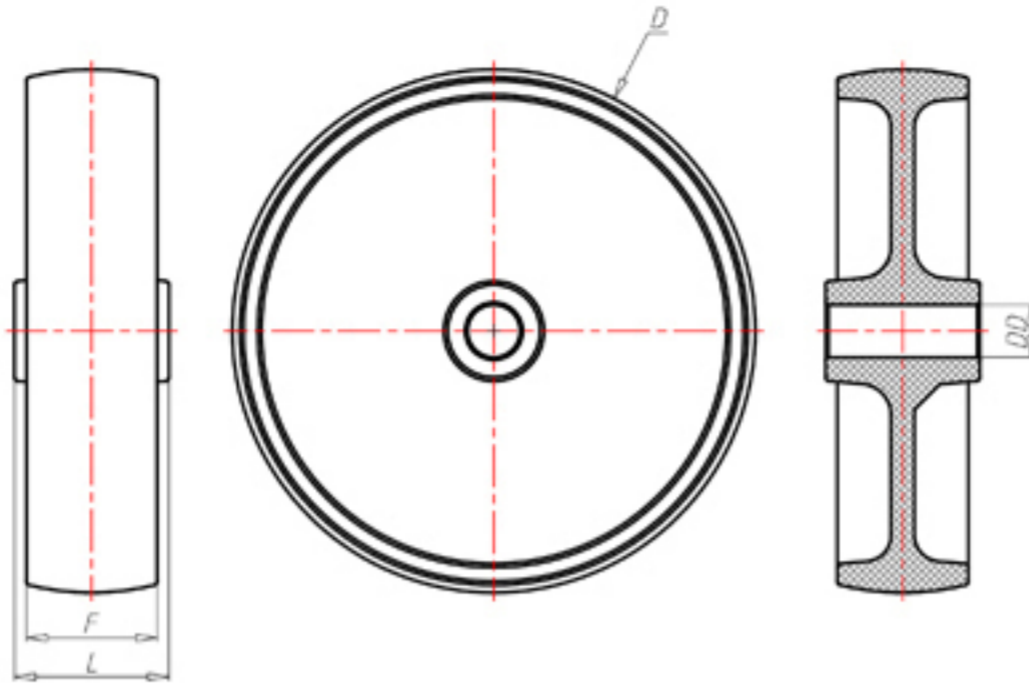

+280°C
-70°C



	D	100
	F	30
	L	40
	DD	Ø 12
	LC	350



Code for plain bore wheel

STW100



Code for wheel with coated bush

-



Code for wheel with double BT self-lube bush

-



Code for wheel with double HT ball bearing

-



Code wheel with double sintered bronze bush

-

