

**DITHERM
STW**

+280°C
-70°C

INOX

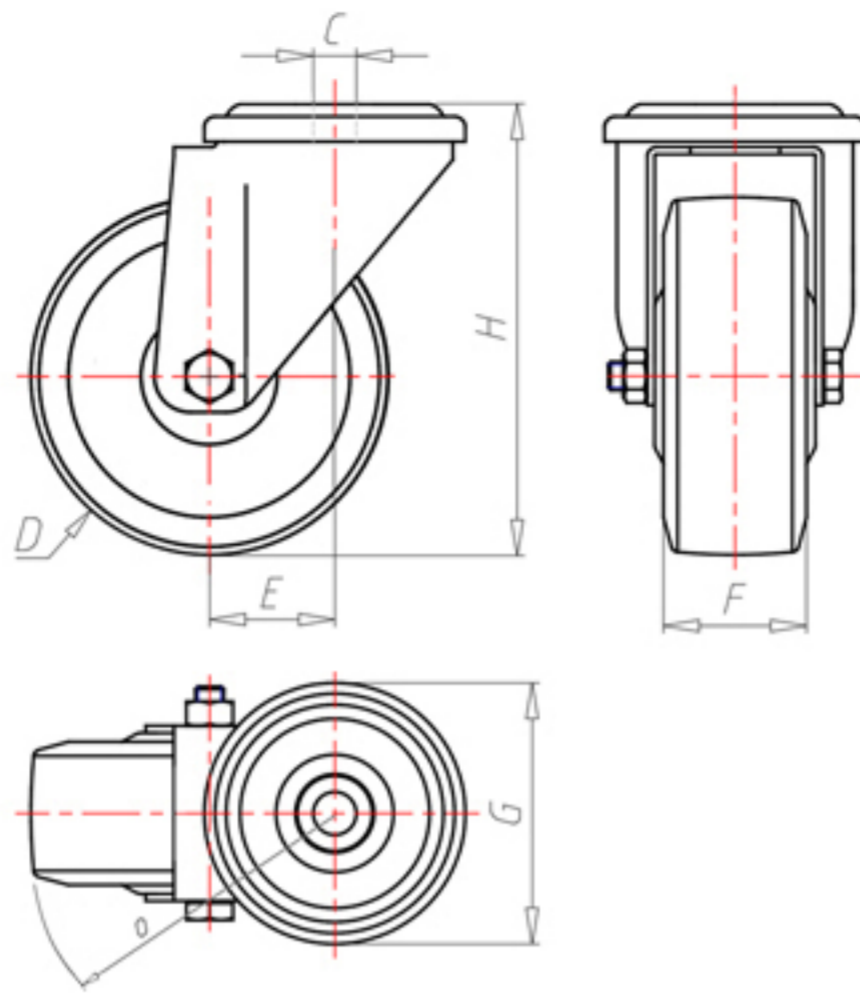

	D	80
	F	30
	H	108
	G	Ø 77
	C	Ø 12
	E	40
	O	82
	LC	200



Code for plain bore wheel

SPX80



Code for wheel with coated bush

SPX80BR



Code for wheel with double BT self-lube bush

SPX80BT



Code for wheel with double HT ball bearing

SPX80C

