

**DITHERM
MTW**

+280°C
-70°C

INOX

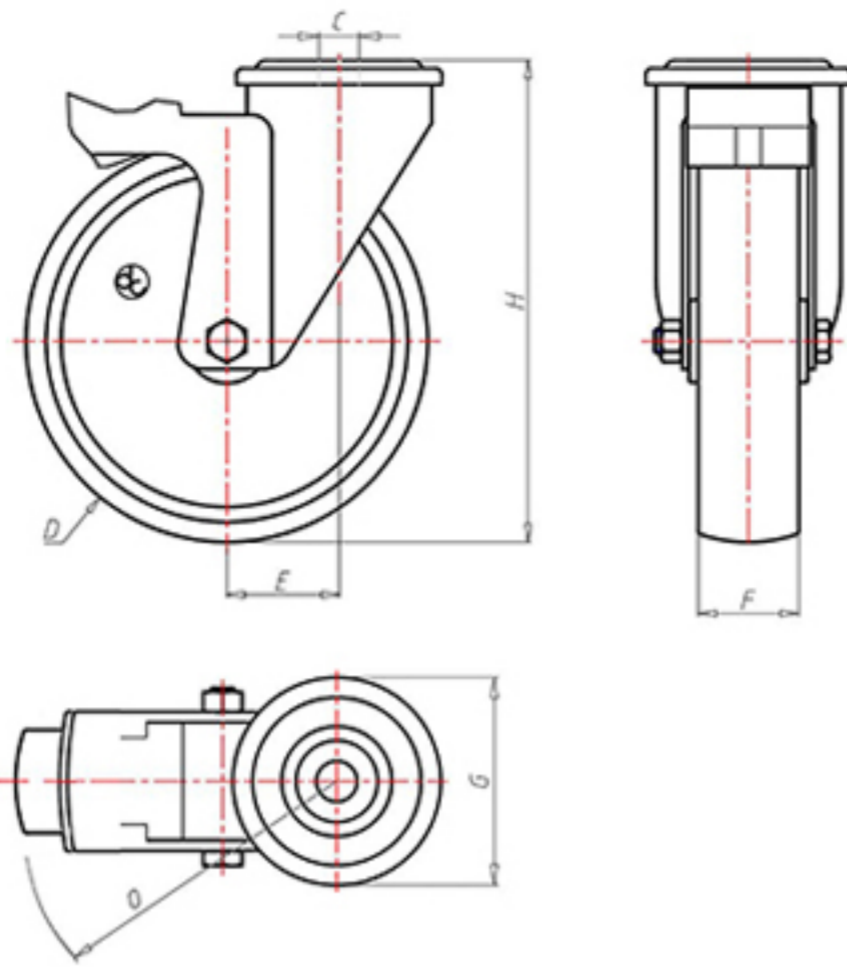

	D	150
	F	40
	H	181
	G	Ø 77
	C	Ø 12
	E	46
	O	124
	LC	250



Code for plain bore wheel

SPX15045FS



Code for wheel with coated bush

SPX15045BRFS



Code for wheel with double BT self-lube bush

-



Code for wheel with double HT ball bearing

-

