

**DITHERM
STW**

+280°C
-70°C

INOX

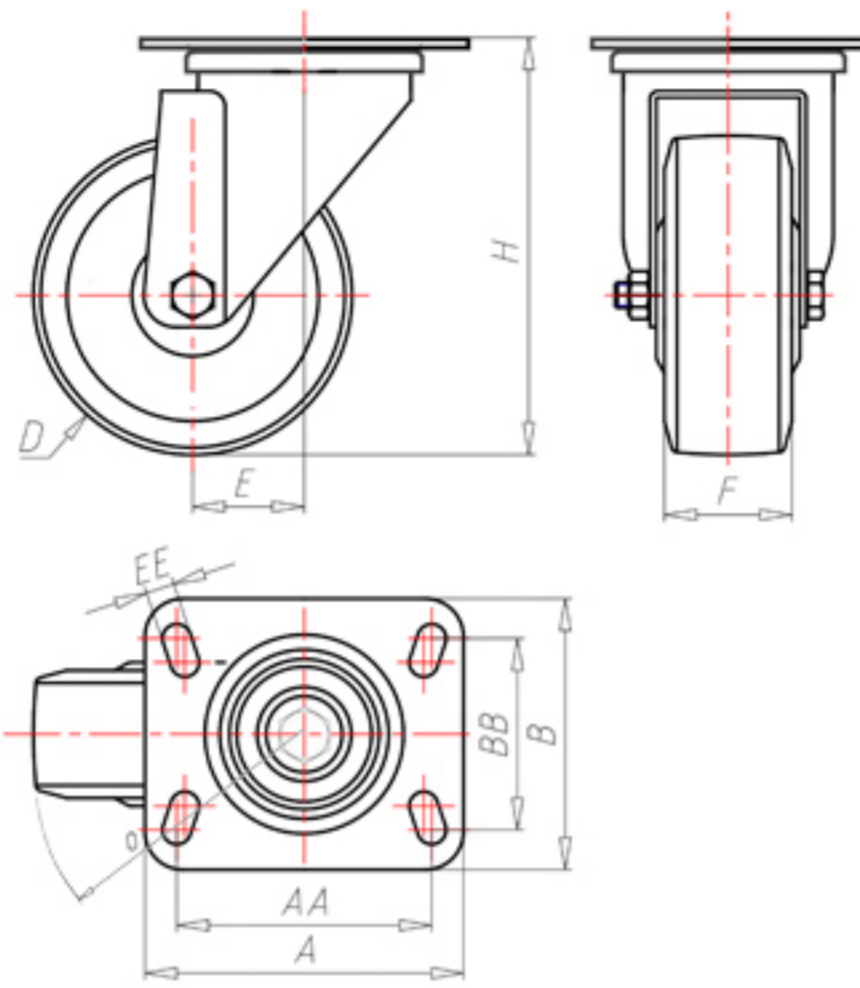

	D	80
	F	30
	H	110
	AxB	100x85
	AAxBB	80x60
	EE	9
	E	40
	O	82
	LC	200



Code for plain bore wheel

SGX80P



Code for wheel with coated bush

SGX80PBR



Code for wheel with double BT self-lube bush

SGX80PBT



Code for wheel with double HT ball bearing

SGX80PC

