

D-NAMIC

92 Shore A
+90°C
-40°C

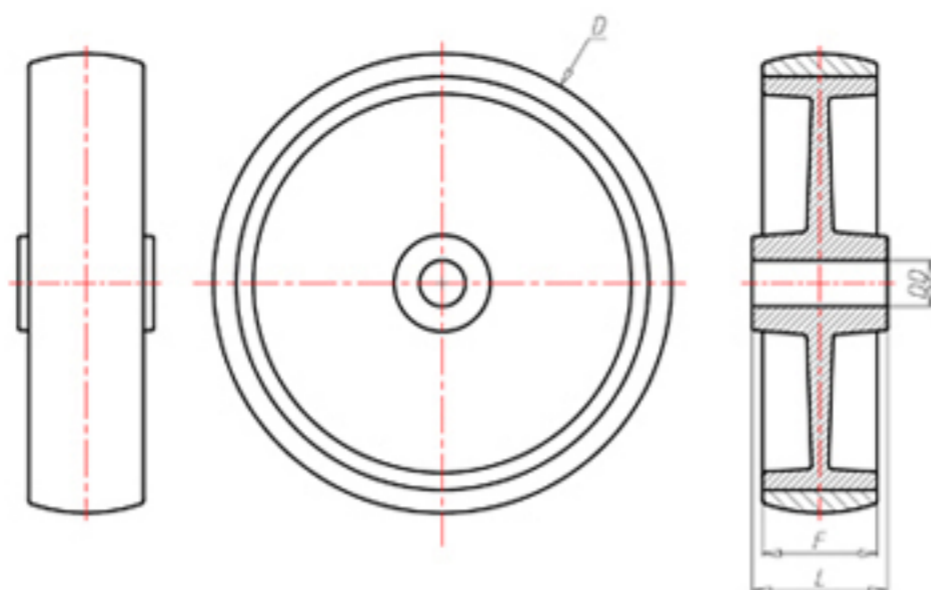

	D	80
	F	33
	L	40
	DD	Ø 12
	LC	240



Code for plain bore wheel

PXN8040



Code for wheel with roller bearing

PXN8040R



Code for wheel with Inox roller bearing

PXN8040RX



Code for wheel with double sealed ball bearing

PXN8040C



Code for wheel with double sealed Inox ball bearing

PXN8040CX

