

D-NAMIC

92 Shore A
+90°C
-40°C

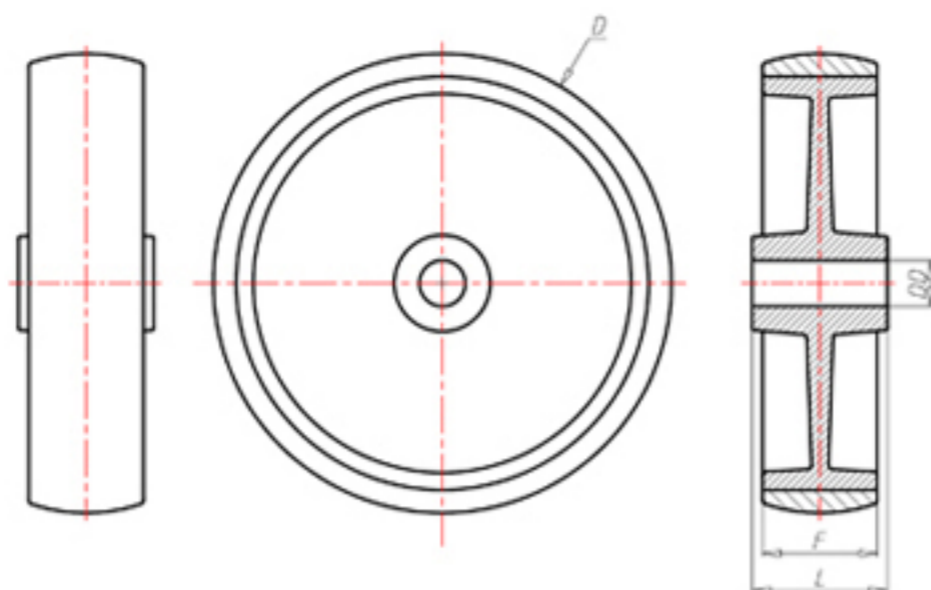

	D	150
	F	40
	L	58
	DD	Ø 20
	LC	500



Code for plain bore wheel

PXN15060



Code for wheel with roller bearing

PXN15060R



Code for wheel with Inox roller bearing

PXN15060RX



Code for wheel with double sealed ball bearing

-



Code for wheel with double sealed Inox ball bearing

-

