

D-NAMIC

92 Shore A
+90°C
-40°C

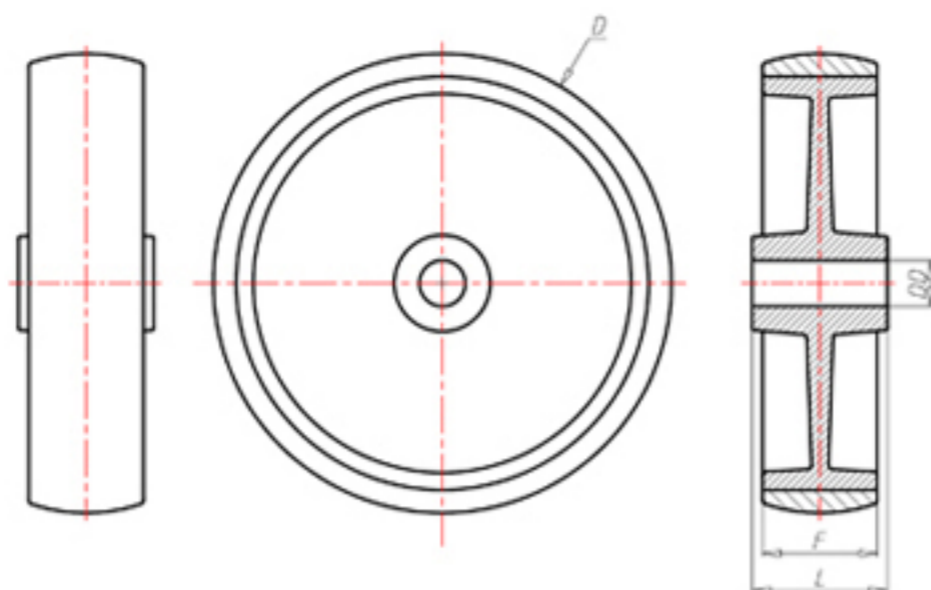

	D	150
	F	40
	L	45
	DD	Ø 15
	LC	380



Code for plain bore wheel

PXN15045



Code for wheel with roller bearing

PXN15045R



Code for wheel with Inox roller bearing

PXN15045RX



Code for wheel with double sealed ball bearing

-



Code for wheel with double sealed Inox ball bearing

-

