

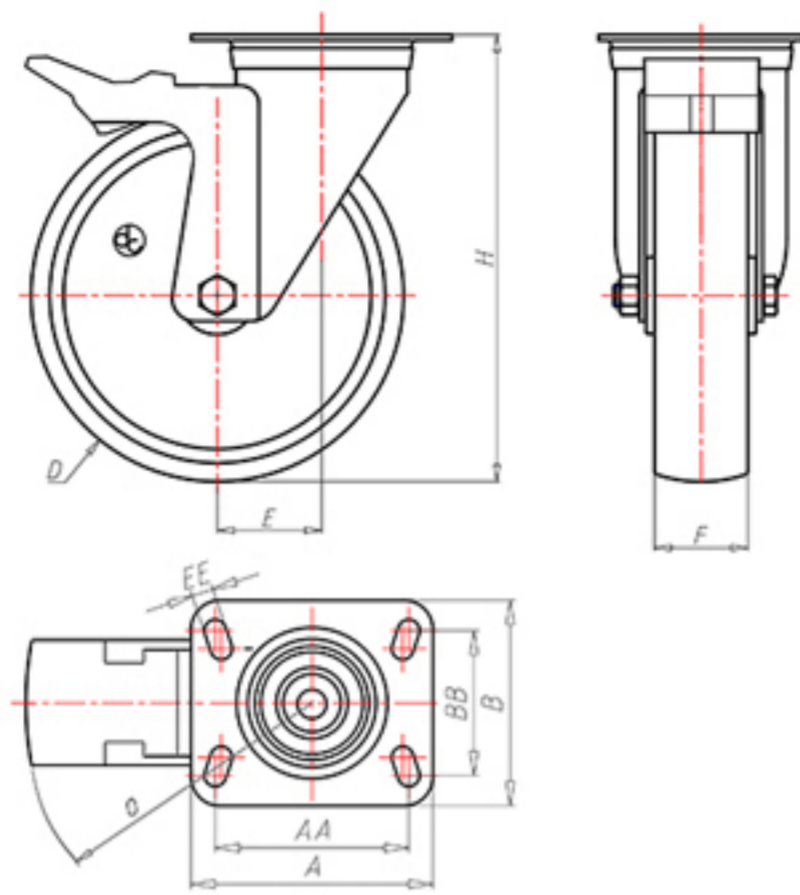

70 Shore D
+90°C
-40°C



	D	150
	F	40
	H	181
	AxB	100x85
	AAxBB	80x60
	EE	9
	E	46
	O	124
	LC	250



Code for plain bore wheel
NYGX15045FA

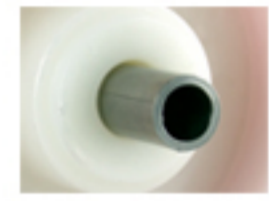

Code for wheel with roller bearing
-



Code for wheel with Inox roller bearing
NYGX15045RXFA

