

**DITHERM
MTW**

+300°C
-40°C

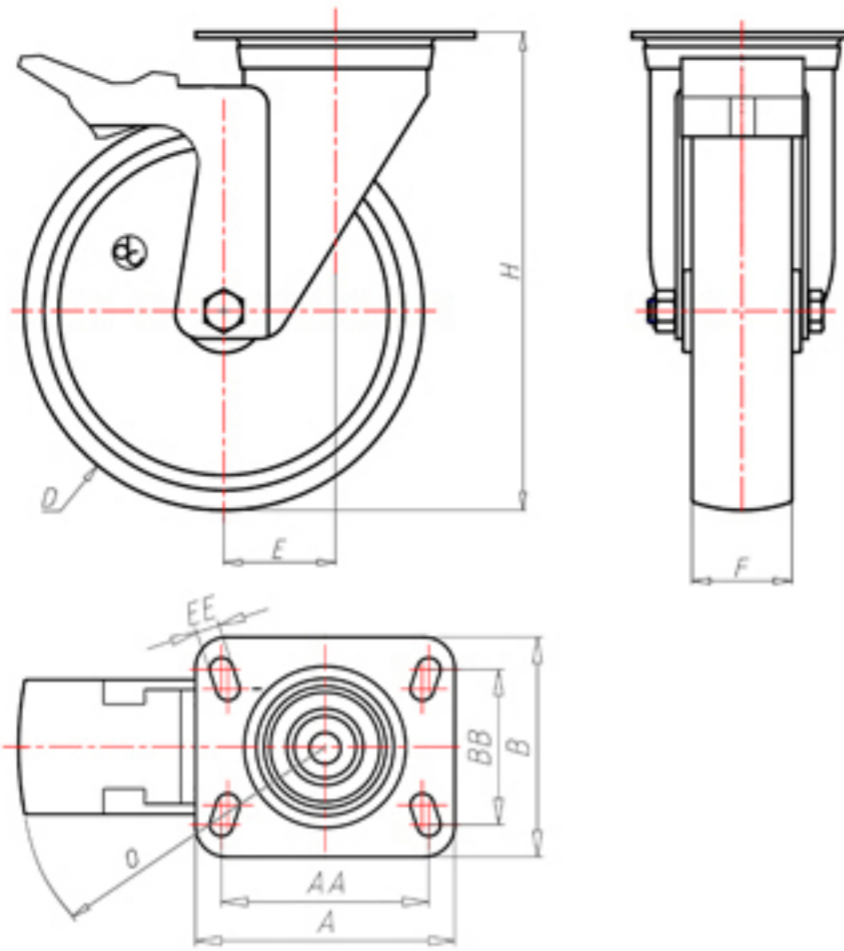

	D	200
	F	50
	H	232
	AxB	135x110
	AAxBB	105x80
	EE	11
	E	56
	O	167
	LC	400



Code for plain bore wheel

MGZ200FA



Code for wheel with coated bush

-



Code for wheel with double BT self-lube bush

-



Code for wheel with double HT ball bearing

-



Code wheel with double sintered bronze bush

MGZ200BSFA

