

**DITHERM
MTW**

+300°C
-40°C

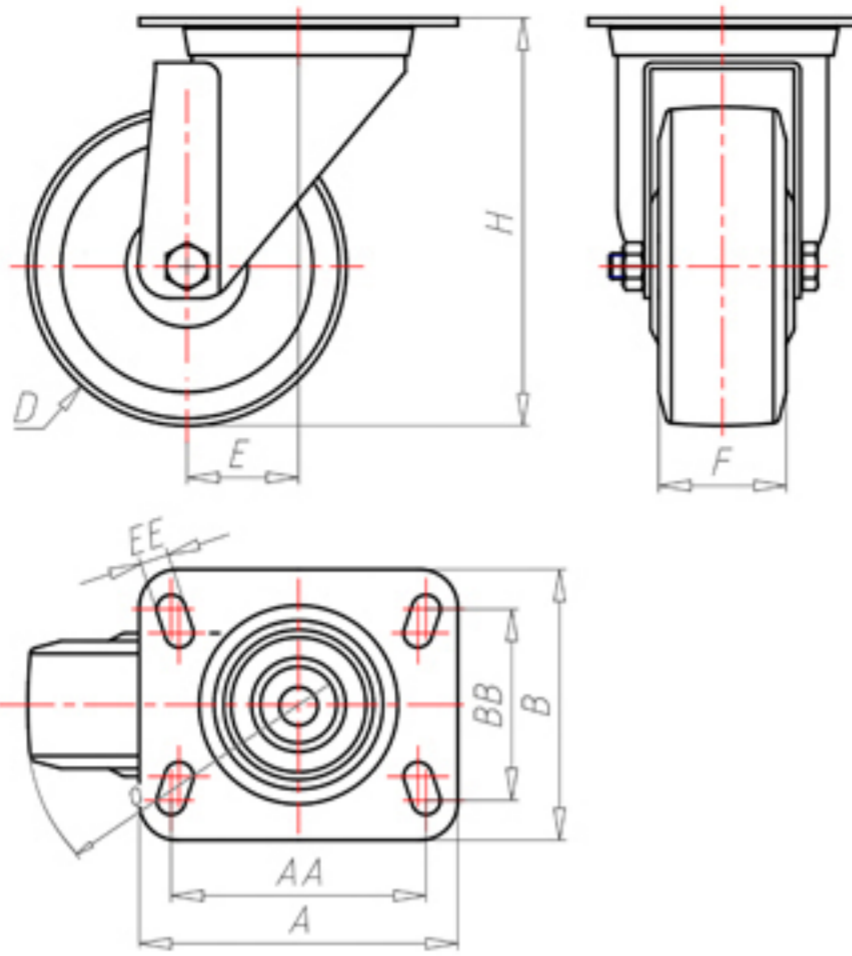

	D	150
	F	45
	H	181
	AxB	135x110
	AAxBB	105x80
	EE	11
	E	52
	O	120
	LC	300



Code for plain bore wheel

MGZ150



Code for wheel with coated bush

-



Code for wheel with double BT self-lube bush

-



Code for wheel with double HT ball bearing

-



Code wheel with double sintered bronze bush

MGZ150BS

